

Power Control ASys ACsys ULTRALIFT

CE FEM 1.001 - A4
EN 14439 - C25 - D25

Torre/Reazioni – Masts/Reactions – Mat/Réactions – Maste/Eckdrücke – Mästil/Reacciones – Tramo/Reacções

SK1700 FEM

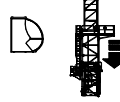
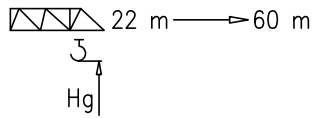

- Hg=Ht-1 m
- ◻ Hg=Ht-1.8 m

4	BPF039	4/4
3	ST117	2/2
2	BAF117	4/2
1	ST039	2/2

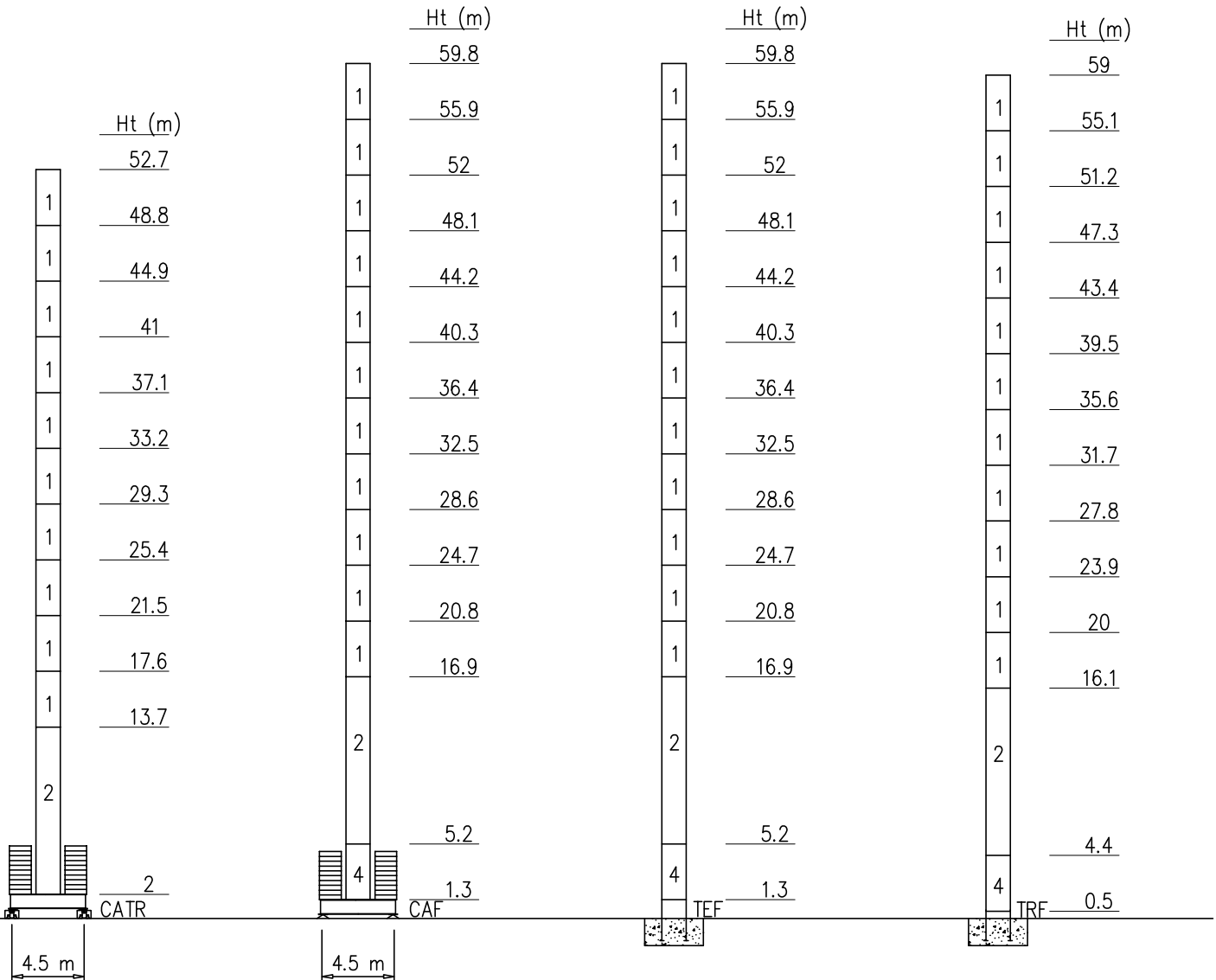

Peso zavorra – Ballast weight – Poids du lest – Ballastgewicht – Peso de lastre

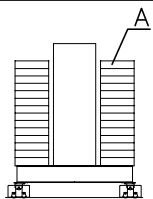

SK1700	
H-CATR020 (m)	48.8 52.7
(t)	77 98
n°	22xA 28xA

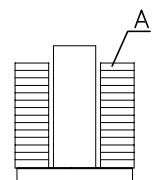
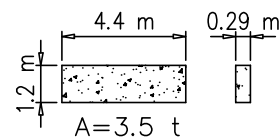

SK1700										
H-CAF013 (m)	24.7	28.6	32.5	36.4	40.3	44.2	48.1	52	55.9	59.8
(t)	42	49	49	56	63	70	84	98	119	147
n°	12xA	14xA	14xA	16xA	18xA	20xA	24xA	28xA	34xA	42xA

Torre/Reazioni – Masts/Reactions – Mat/Réactions – Maste/Eckdrücke – Mästil/Reacciones – Tramo/Reacções

SK1700 EN14439-C25

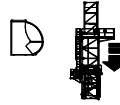
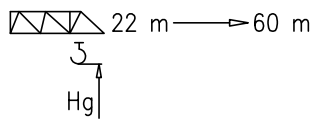

4	BPF039	4/4
3	ST117	2/2
2	BAF117	4/2
1	ST039	2/2

- Hg=Ht-1 m
- Hg=Ht-1.8 m

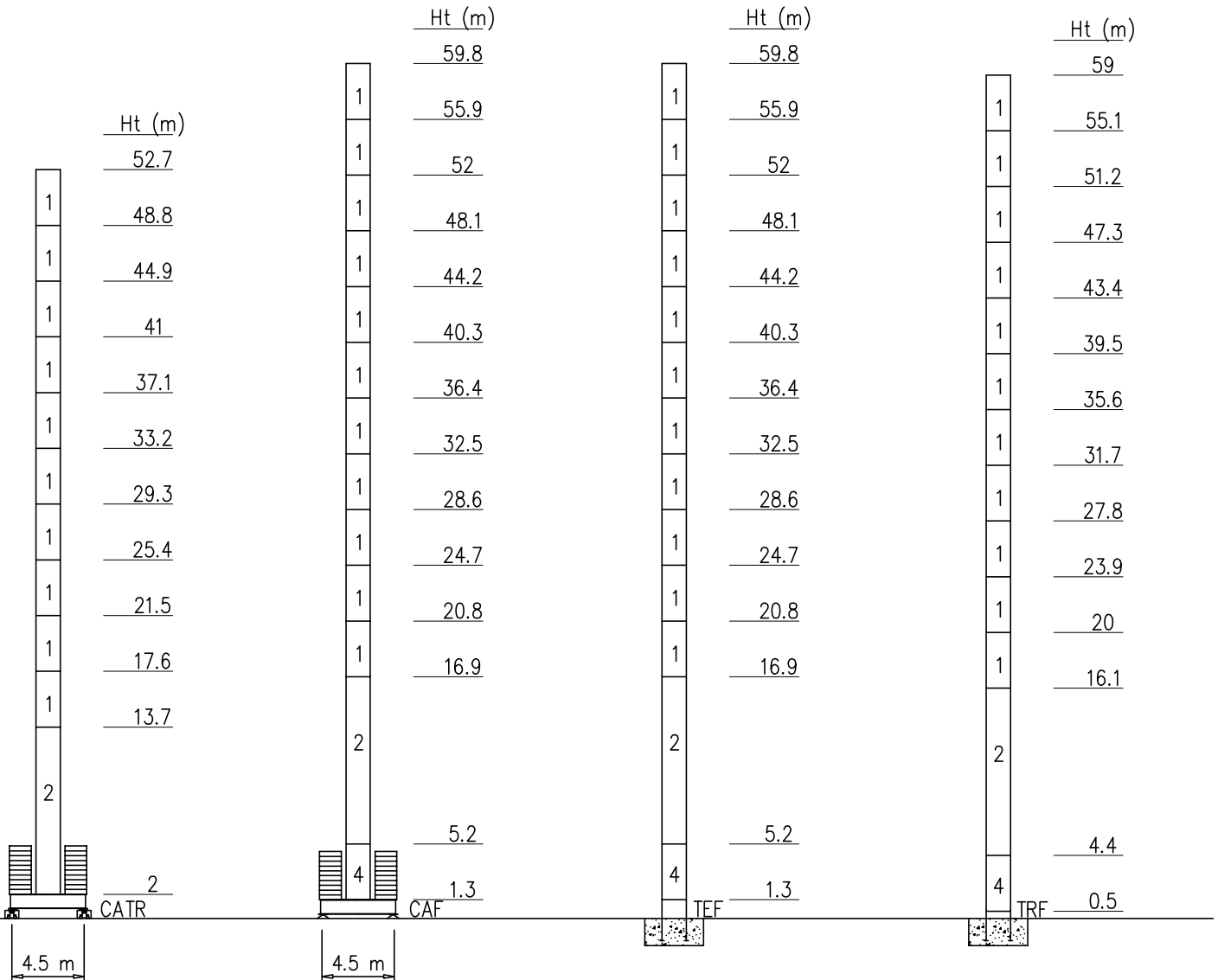

Peso zavorra – Ballast weight – Poids du lest – Ballastgewicht – Peso de lastre

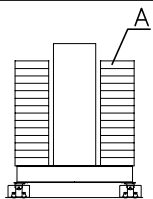

SK1700		
H-CATR020 (m)	48.8	52.7
(t)	84	119
n°	24xA	34xA

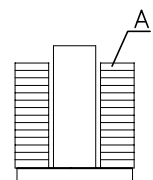
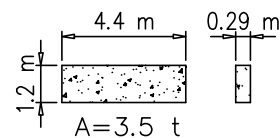

SK1700											
H-CAF013 (m)	24.7	28.6	32.5	36.4	40.3	44.2	48.1	52	55.9	59.8	
(t)	42	49	49	56	63	70	84	119	126	154	
n°	12xA	14xA	14xA	16xA	18xA	20xA	24xA	34xA	36xA	44xA	

Torre/Reazioni – Masts/Reactions – Mat/Réactions – Maste/Eckdrücke – Mästil/Reacciones – Tramo/Reacções

SK1700 EN14439-D25

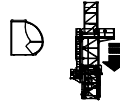
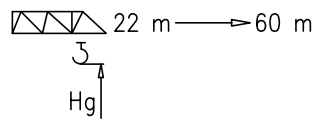

- Hg=Ht-1 m
- ◻ Hg=Ht-1.8 m

4	BPF039	4/4
3	ST117	2/2
2	BAF117	4/2
1	ST039	2/2

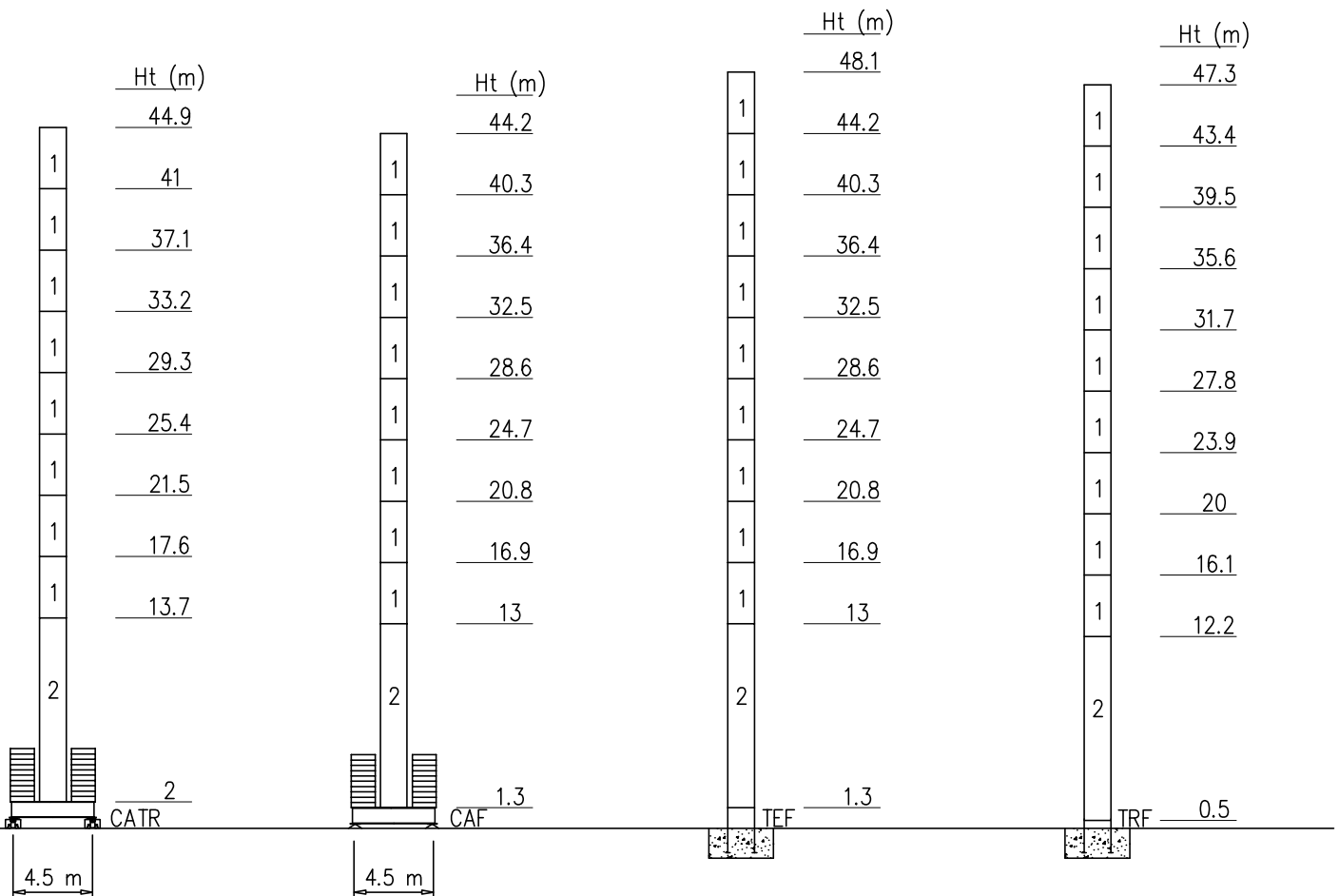

Peso zavorra – Ballast weight – Poids du lest – Ballastgewicht – Peso de lastre

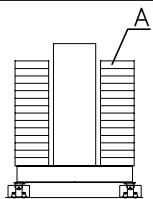



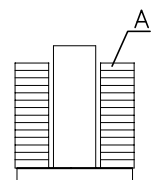
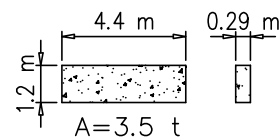











SK1700	
H-CATR020 (m)	44.9
(t)	119
n°	34xA









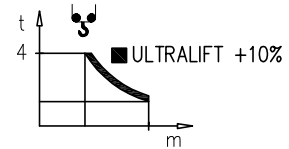







SK1700						
H-CAF013 (m)	24.7	28.6	32.5	36.4	40.3	44.2
(t)	49	49	56	63	77	119
n°	14xA	14xA	16xA	18xA	22xA	34xA

Curve di carico – Courbes de charges – Load diagrams – LastKurven – Curvas de cargas







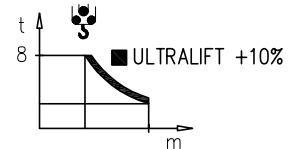

	18360 kg		60 m	2	25.5	27.5	30	32.5	35	37.5	40	42.5	45	47.5	50	52.5	55	60	m
				4000	4000	3600	3300	3000	2740	2500	2320	2150	2000	1850	1740	1630	1500	1350	kg
	18360 kg		55 m	2	26.7	27.5	30	32.5	35	37.5	40	42.5	45	47.5	50	52.5	55	m	
				4000	4000	3820	3480	3150	2890	2630	2450	2250	2100	1950	1840	1730	1600	kg	
	18360 kg		50 m	2	27.8	30	32.5	35	37.5	40	42.5	45	47.5	50	m				
				4000	4000	3650	3300	3040	2710	2580	2400	2270	2080	1950	kg				
	17160 kg		44.5 m	2	29.5	30	32.5	35	37.5	40	42.5	44.5	m						
				4000	4000	3920	3550	3260	2950	2770	2550	2450	kg						
	17160 kg		38.5 m	2	30.8	32.5	35	38.5	m										
				4000	4000	3750	3430	3050	kg										
	15600 kg		33 m	2	32.7	33	m												
				4000	4000	3950	kg												
	12480 kg		22 m	2	22	m													
				4000	4000	kg													

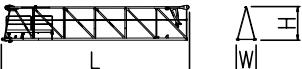
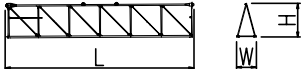
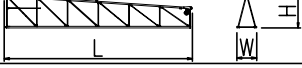

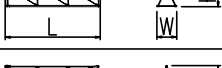
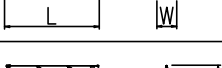
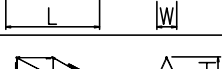
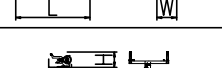
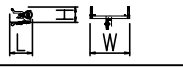
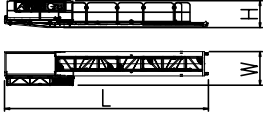

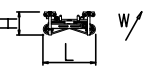
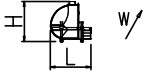
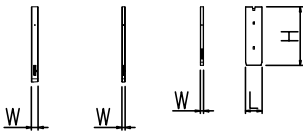
	18360 kg		60 m	2	13.9	15	20	22.5	25	27.5	30	32.5	35	37.5	40	42.5	45	47.5	50	52.5	55	60	m
				8000	8000	7320	5230	4700	4000	3600	3190	2930	2610	2410	2190	2000	1920	1720	1600	1500	1390	1200	kg
	18360 kg		55 m	2	14.5	17.5	20	22.5	25	27.5	30	32.5	35	37.5	40	42.5	45	47.5	50	52.5	55	m	
				8000	8000	7670	5480	4800	4200	3700	3360	3000	2760	2500	2310	2100	2000	1730	1700	1570	1450	kg	
	18360 kg		50 m	2	15	20	22.5	25	27.5	30	32.5	35	37.5	40	42.5	45	47.5	50	m				
				8000	8000	5740	5000	4400	3950	3520	3200	2900	2600	2440	2240	2130	1930	1800	kg				
	17160 kg		44.5 m	2	15.9	20	22.5	25	27.5	30	32.5	35	37.5	40	42.5	44.5	m						
				8000	8000	6130	5350	4710	4200	3780	3410	3120	2880	2630	2400	2300	kg						
	17160 kg		38.5 m	2	16.5	20	22.5	25	27.5	30	32.5	35	38.5	m									
				8000	8000	6430	5550	4950	4450	3980	3610	3290	2900	kg									
	15600 kg		33 m	2	17.5	20	22.5	25	27.5	30	33	m											
				8000	8000	6880	6000	5300	4720	4270	3800	kg											
	12480 kg		22 m	2	17	20	22	m															
				8000	8000	6650	6000	kg															

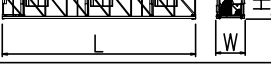

PESI E INGOMBRI – PACKING LIST – LISTE DE COLISAGE – GEWICHT UND ABMESSUNGEN

Denominazione Description	Disegno Draw	Pezzi Pieces	Dimensioni-Dimensions (mm)			Peso-Weight (kg)		
			L	W	H	Unit	Total	
Elemento di braccio Jib element Elément de èche Elemento de flecha	n°8 	1	11400	1100	2280	2520	–	
	n°7 	1	11425	1100	2055	1430	–	
	n°6 	1	11400	1100	2055	1120	–	
	n°5 	1	5790	1100	1610	470	–	
	n°4 	1	5755	1100	1610	360	–	
	n°3 	1	5725	1100	1260	270	–	
	n°2 	1	5680	1100	1260	235	–	
	n°1 	1	4500	1100	1260	160	–	
	Punta braccio 	1	700	1100	500	45	–	
Controbraccio completo Complete counterjib Contreflèche complète Contraflecha completa		1	10350	1710	1400	2500	–	
Gruppo girevole Slewing group Table tournante Grupo giratorio	TK1700 	1	2300	1810	2900	4500	–	
Carrello Trolley Chariot Carretilla	P8 	1	1600	1620	710	370	–	
Ballatoio con cabina Access balcony with cabin Porte cabine Balcòn corrido con cabina		1	2500	2150	2450	1000	–	
Blocchi contrappeso Counterweight block Contre-poids Bloques de contrapeso	VX31 VX24 VS12 	VS12	1	1000	200	2500	1200	1200
		VS15	1	1000	200	3550	1560	1560
		VX31	5	1000	400	3550	3120	15600
Elemento di torre Mast element Elément de mature Elemento de torre	ST039 	SK1700	–	3900	1785	1785	1750	–
	BPF039 	SK1700	–	3900	1925	1925	2640	–
	ST117 	SK1700	–	11700	1785	1785	4690	–
	BAF117 	SK1700	–	11700	1785	1785	7100	–

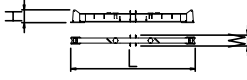
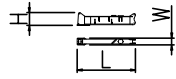
PESI E INGOMBRI – PACKING LIST – LISTE DE COLISAGE – GEWICHT UND ABMESSUNGEN

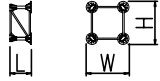
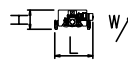
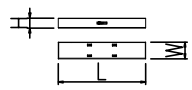
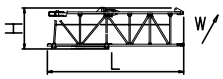
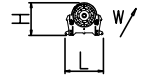
Denominazione Description	Disegno Draw	Pezzi Pieces	Dimensioni-Dimensions (mm)			Peso-Weight (kg)		
			L	W	H	Unit	Total	
Carro di base Base carriage Chassis de base Cruceta de base		4.5x4.5	1	7550	800	1100	4500	4500
		4.5x4.5	2	3530	500	1100	2060	4120
Elemento a perdere Disposable frame Chassis a perdre Bastidor desechable		SK1700	1	1840	1910	1910	1430	-
Elemento recuperabile Recoverable frame Chassis r�cup�rable Bastidor recuperable		SK1700	1	1300	2170	2170	1720	-
Bogie di traslazione Driven bogie Boggie motoris�e Balanc�n de traslaci�n		4	1160	700	600	700	2800	
Blocco zavorra di base Base ballast block Lest de base Bloque de lastre		4.5x4.5	-	4400	1200	290	3500	
Corsoio di montaggio Climbing cage Cage de montage Jaula de montaje		SK1700	1	8300	2600	2500	6000	-
Argano sollevamento Hoisting winch Treuli de levage Mecanismo de elevaci�n		V33.60	1	930	790	2300	1250	-
		V45.90	1	930	840	2300	1570	-
		V45.120	1	930	900	2300	1600	-
		V25.60	1	930	840	2300	800	-
		V33.90	1	930	840	2300	1400	-

GRU IN CAVEDIO – TELESCOPAGE SUR DALLES – CLIMBING CRANE – KLETTERKRANE IM GEBAUDE

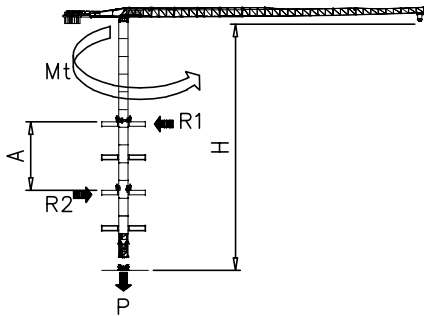

SK1700	H (m)	A (m)
	39	Min 9
Apertura passaggio gru Opening for crane passing 		Max 12

II= in servizio con vento – in service with wind – III= fuori servizio con vento 150 km/h – out of service with wind 150 km/h
SOPRALZO IDRAULICO – TELESCOPABLE – EXTERNAL CLIMBING – KLETTERKRANE

FEM

		SK1700	
		II	III
MAX	C	32.5 m	
	B	19.5 m	
	A	46.8 m	

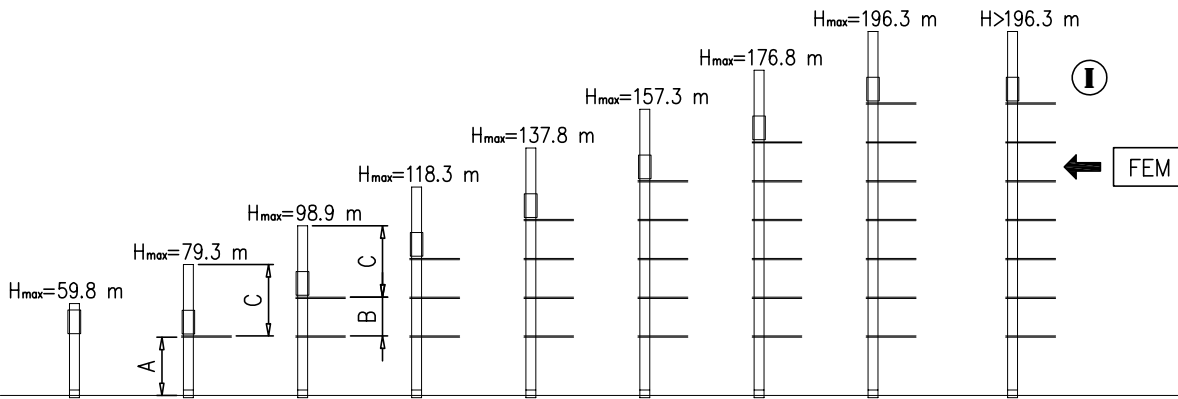
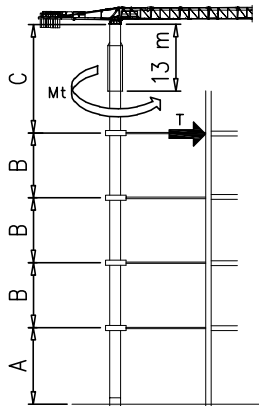

Montaggio – Montage – Erection – Montage – Montaje – Montagem

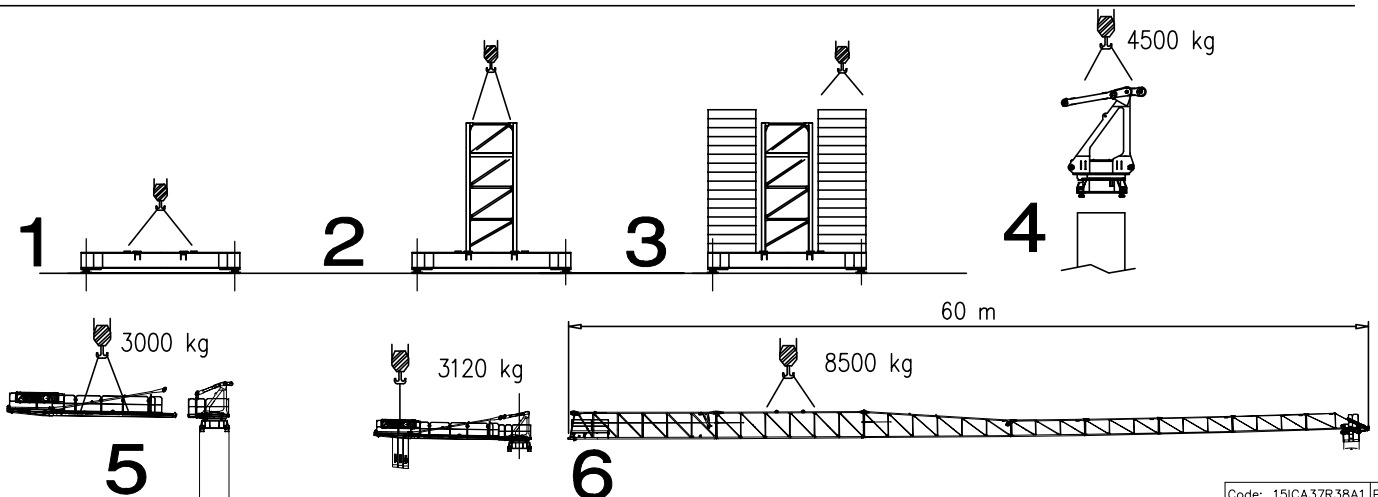

Meccanismi – Mechanisms – Mécanismes – Antriebe – Mecanismos

P8 V30.60													V30.60 22 kW 40 kVA 240 m 480 m (L)	
	m/min	2.5	15	27	43	56	71	1.2	7.5	13.5	21.5	28		35.5
	t	4	4	4	2.5	1.7	0.8	8	8	8	5	3.4		1.6
Sollevamento Hoisting Levage Heben Elevaciòn Elevaçao														

P8 V45.90													V45.90 33 kW 58 kVA 340 m 680 m (L)	
	m/min	4	18	36	56	74	90	2	9	18	28	37		45
	t	4	4	4	3	2	1	8	8	8	6	4		2
Sollevamento Hoisting Levage Heben Elevaciòn Elevaçao														

Carrello Trolleying Distribution Katzfahren Distribuição			0 → 80	m/min	5.5 kW	Potenza elettrica necessaria Puissance électrique nécessaire Necessary electric power Anschlusswert – Potencia
Rotazione Slewing Orientation Schwenken Orientación Rotação			0 → 0,9	giri/min tr/min rp/min	4.4 kW @ 1200rpm n° 2 x 2.2 kW (n°2x6.5 kgm)	
Traslazione Travelling Translation Kranfahren Traslación Translação			0 → 20	m/min	7.5 kW	
Rete elettrica – Réseau – Mains supply – Netzstrom – Red – Rede electrica					400V – 50 Hz	

AFM Gru FMgru s.r.l.
via Emilia 11–29010 Pontenure PC ITALY
tel. +39 0523/510446 ric.autax +39 0523/510365
www.fmgru.it e-mail: info@fmgru.com

FEM 1.001 – A4
EN 14439 – C25 – D25



Documento commerciale non contrattuale
Per tutte le informazioni tecniche riferirsi
alle corrispondenti istruzioni

Unverbindliches Vertriebsdokument.
Für technische Informationen, siehe die
entsprechenden Anweisungen.

This commercial document is not legally
binding. For any technical information, please
refer to the corresponding instructions.

Documento comercial no contractual
Para cualquier información técnica,
ver la noticia correspondiente.

Code: 15ICA37R38A1 P.9
Rev. 3 Data 04.07.17